

VFD500 series high performance AC drive



Innovation/Technology/High Quality



ShenZhen VEIKONG Electric CO., Ltd.

Factory Address: Block E01,first industrial park lingbei 5 road ,
phoenix community,fuyong street , Bao'anDistrict, Shenzhen ,China

Technical Support Hotline: +86-0755-89587650

Web Site: www.veikong-electric.com

Service Address:



CHINA SHENZHEN

SHENZHEN VEIKONG ELECTRIC CO., LTD
VEIKONG INDUSTRIAL CO.,LIMITED (HK)



Brief introduction

Shenzhen Veikong Electric CO.,Ltd. a high-tech enterprise which has been specializing in researching, manufacturing and trading high, medium and low voltage inverter, providing our clients with integrated system solutions. We have professional R&D and devoted management team with more than 20 years' experience of theoretical research, product development and quality management. Veikong also is one of the first independent AC drives company in China. We adopt SPWM, sensorless vector control and vector and torque control technology in our VFD series inverters, which has reached the international advanced standard. The products can directly replace and be equivalent of Europe and the United States, Japan and other brands, providing customers with a powerful technical support. We have achieved popularity and qualification in VFD industry. Quality is the life of enterprise.



Veikong drives keeps following ISO9001 standard to manage and supervise quality. Our products have passed CE certification and other technical approval. To better meet customer requirements and market needs, Veikong drives keeps on upgrading new technologies and new products.

The customer is the source of enterprise. We are honored to put top priority on customers' requirements as well as achieving their requirements. Our products have been widely used in petroleum, chemical, melting, hoisting, electric power, building materials, water supply, plastics, textiles, printing, packing and other industries to create value for customers.



PCBA Production Line and Test



Burn-in

Lacquer

Assemble



Automatic DT test platform

Automatic PCBA ATE test platform

Automatic FLASH test platform

Strong R&D Power

- Board design: ECAD design platform-Mentor, Network design constraint Netclass(set network width and distance)

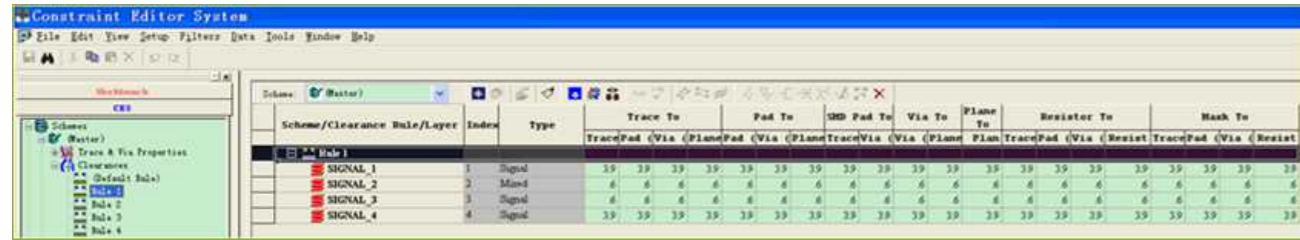

- Schematic diagram interdesign with PCB to a perfect extent with complete serious checking function

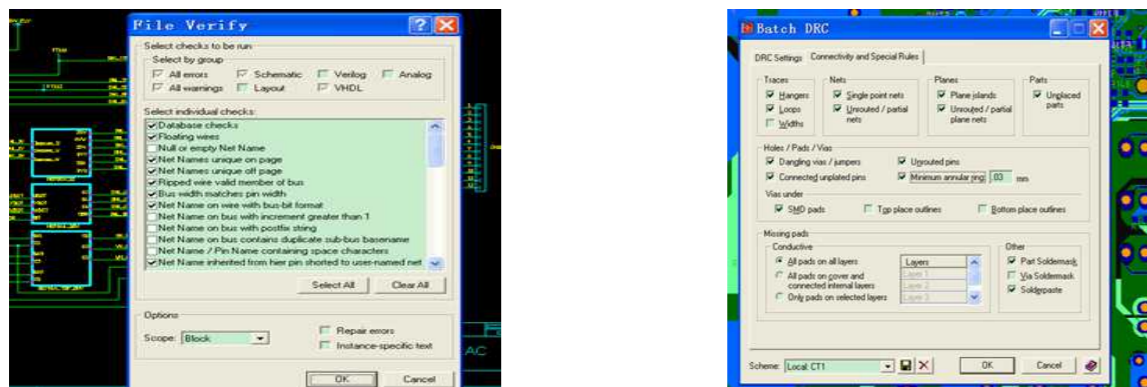

- Power module design platform-heat model design

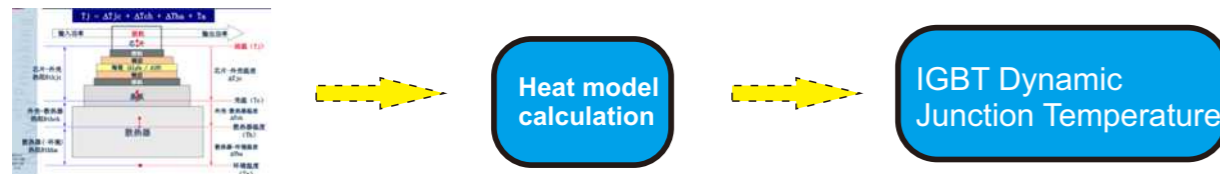

- Power Electronics design-IGBT Pulse Test

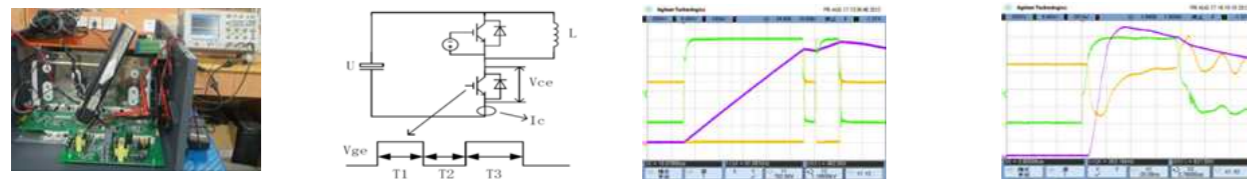

- Software design: powerful function: Simulink-MotorControl simulation platform:



Advanced Instruments and Equipments



Thermal imaging system



Programming integrated testing system



PM3000 power analyzer



Programming temperature box



Programming high voltage insulator



Signal generator



Signal analyzer



- Professional EMC& safety



AC source Surge Noise coupler EFT



ESD tester



8KV high voltage probe systems



Safety instruments

Drive design & features

Even more compact

- ▶ VEIKONG continues to make applications even smaller by combining the compact designed drive with the light, efficient design of a synchronous motor.
- ▶ Use Side-by-Side installation for an even more compact setup.
- ▶ Finless models available*.

* Coming soon

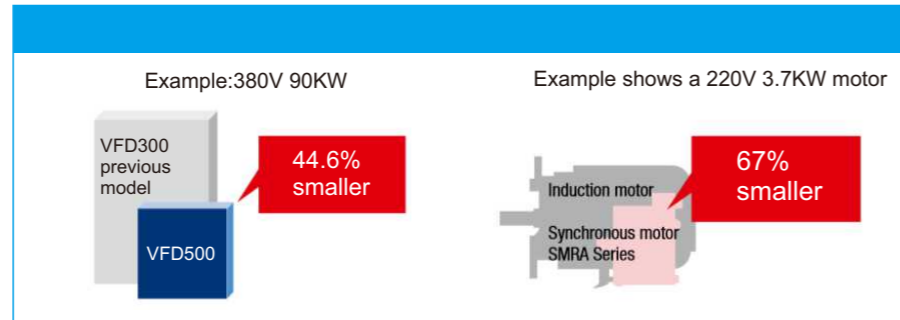

Independent duct design

- ▶ Independent air duct design, effectively preventing dust entering inverter, causing short-circuit and other faults and improving reliability
- ▶ Use bigger air volume and long life cooling fan effectively reduces the internal temperature rise of the inverter and ensures reliable and stable operation of inverter.

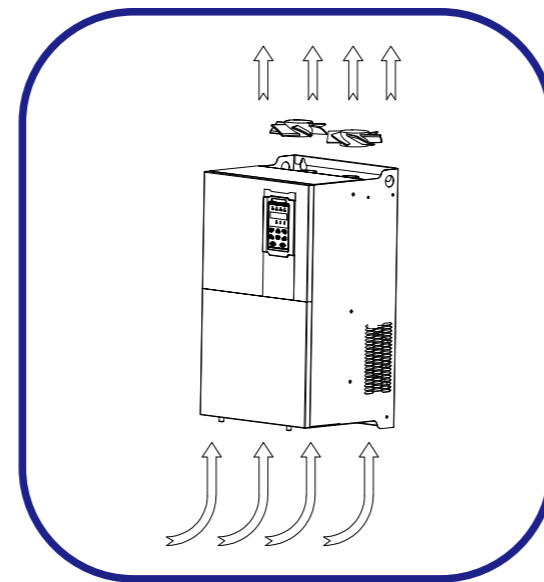

Perfect protection system

- ▶ Designed for 10 years of maintenance-free operation.
- ▶ Cooling fan, capacitors, relays, and IGBTs have been carefully selected and designed for a life expectancy up to ten years.

* Assumes the drive is running continuously for 24 hours a day at 80% load with an ambient temperature of 40°C



High speed accuracy and wide speed range

- ▶ High speed accuracy and wide speed range
Steady speed accuracy: $\pm 0.5\%$ (SVC), $\pm 0.02\%$ (VC)
Speed range: 1:200 (SVC), 1:1000 (VC)
Heavy load overload capability:
- ▶ 110% rated current for long-term stable operation
150% rated current for 1 minute
180% rated current 10s

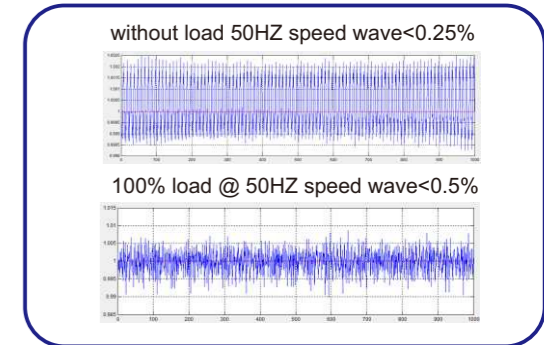

High torque in low speed, fast response

- ▶ High torque in low speed, fast response
Load capacity in low speed:
- ▶ VF: 180% @ 0.50Hz
SVC: 180% @ 0.25Hz
VC: 200% @ 0.00Hz

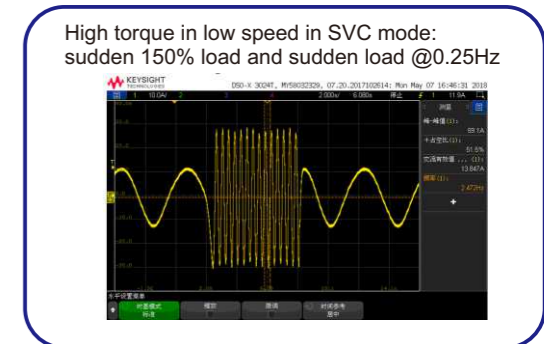

Rapid response to impact loads

- ▶ When it meets with sudden load change, inverter can quickly restore the speed, reduce the speed fluctuation, and ensure the production stability and high quality finished products.

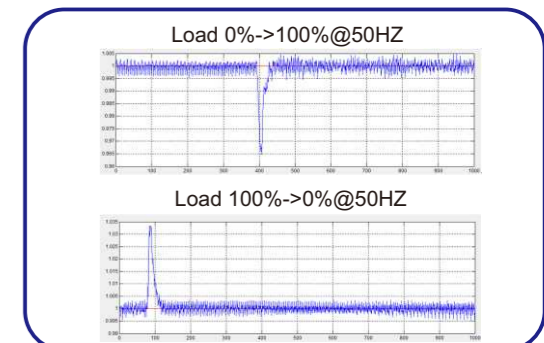

Optimized SVC algorithm, stable operation in power generation

- ▶ At present, most of the inverters can not work stably under the SVC control mode (especially in the case of being reversed).
- ▶ VFD500 can run very well, and it achieves great convenience in some special applications (such as tension control in rewinding and winding).

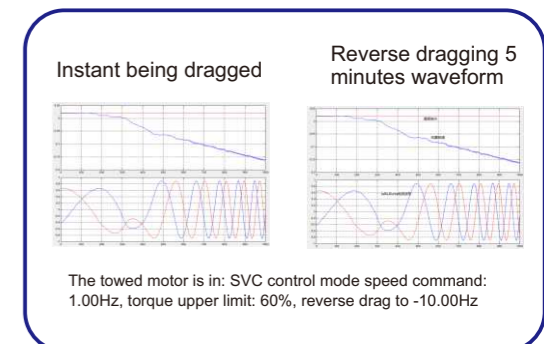

Advanced motor control

Advanced drive technology

- ▶ Capable of driving different types of motor. VFD500 series runs not only induction motors, but also synchronous motors like IPM*1 and SPM*2 motors with high performance open and closed loop vector control.
- ▶ Minimize equipment needed for your business by using the same drive to run induction and synchronous motors.

*1 Interior Permanent Magnet Motor (Motors with permanent magnets inserted into the rotor)

*2 Surface Mounted Permanent Magnet Motor (Motors with permanent magnets mounted on the surface of the rotor)

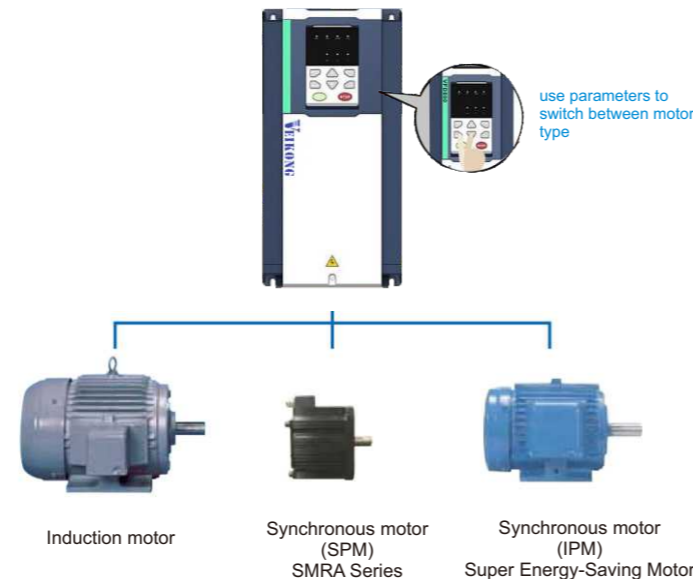

Positioning Capability without External Devices

- ▶ Use an IPM motor to perform position control – without motor feedback. Electrical saliency in IPM motors makes it possible to detect speed, direction and rotor position without the use of external feedback devices.

- ▶ Positioning functionality without a PLC. Visual programming in DriveWorcsEZ eliminates the need for external controllers by giving the user the power to create customized functions such as position control.

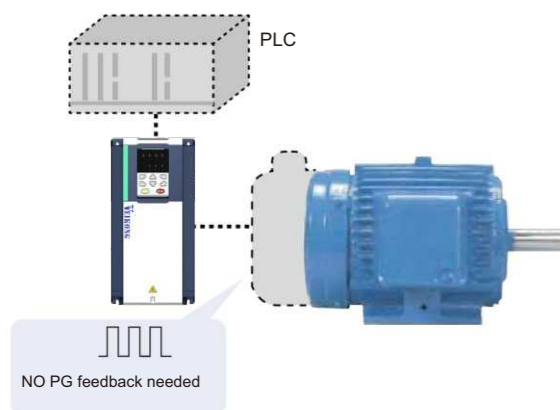

New Auto-tuning features

- ▶ Auto-Tuning features optimize drive parameters for operation with induction motors as well as synchronous motors to achieve the highest performance levels possible.
- ▶ Optimizing not only the drive and motor performance, but also automatically adjusts settings relative to the connected machinery.
- ▶ New Auto-Tuning methods. VFD500 continuously analyzes changes in motor characteristics during operation for highly precise speed control.

Synchronous Motor	
Rotational Auto-Tuning	Applications requiring high starting torque, high speed, and high accuracy.
Stationary Auto-Tuning	Applications where the motor must remain connected to the load during the tuning process.
Line-to-Line Resistance Auto-Tuning	For tuning after the cable length between the motor and drive has changed, or when motor and drive capacity ratings differ.
Encoder Auto-Tuning	For running the motor at top efficiency all the time

Tuning the Load	
ASR*Tuning	Perfects responsiveness relative to the machine. Until now, this tuning procedure was fairly time consuming to set.
Inertia Tuning	Optimizes the drive's ability to decelerate the load. Useful for applications using Kinetic Energy Buffering Function and Feed Forward functions.

Powerful Torque Characteristics

- ▶ Powerful torque at 0 Hz, without sensors or feedback devices. Until recently, sensorless control has been out of reach for synchronous motors.
- ▶ VFD500 series provides powerful starting torque algorithm without relying on pole sensors or motor feedback.
- ▶ High-performance current vector control achieves powerful starting torque with an induction motor.

Torque characteristics
Advanced Open Loop Vector with an IPM motor

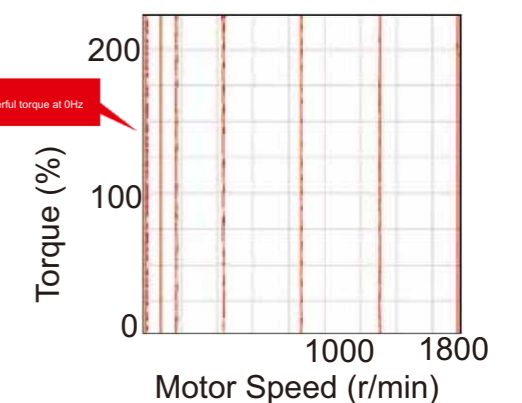

Synchronous Motor	
Advanced Open Loop Vector for PM motors	200% rated torque at 0 r/min*, speed range of 1:100*
Closed Loop Vector Control for PM motors	200% rated torque at 0 r/min, speed range of 1:1500

* only IPM motor

Induction motor	
Open Loop Vector Control	200% rated torque at 0.3 Hz*, speed range of 1:200
Closed Loop Vector Control	200% rated torque at 0 r/min*, speed range of 1:1500

* Proper output torque depends on matching drive and motor capacity.

Stable and reliable

Deceleration over excitation function

- ▶ Accurate thermal simulation platform software ensures the reliability of thermal simulation.
- ▶ Each VFD500 inverter has undergone thermal simulation testing, and only the physical prototype is developed within the scope of the thermal simulation safety design requirements. After the actual test, the thermal simulation results are very close to the physical test results. In the limit test state, the thermal simulation can replace the actual load simulation and an additional layer of scientific thermal test.

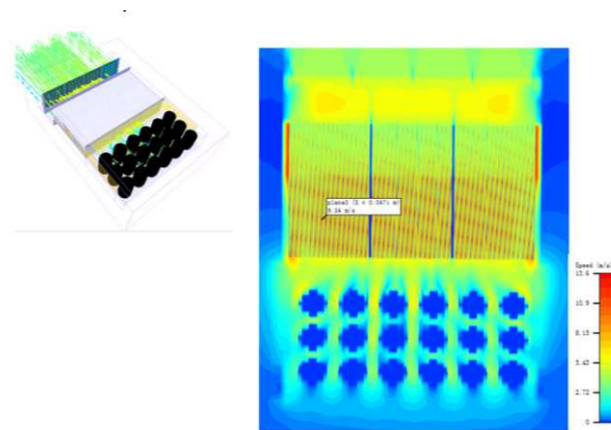

Rigorous temperature rise test

- ▶ The whole machine temperature rise test uses the most severe cyclic overload test to meet the long-term reliable operation under extreme load conditions.
- ▶ Cyclic overload test: 1.5 times overload current for 1 minute, ambient current for 4 minutes, and 1.5 times operation for 1 minute at ambient temperature of 40°.
- ▶ This continuous cycle operation, 1 cycle for 5 minutes, until the system reaches the thermal equilibrium state, the whole machine is within the thermal design safety range.

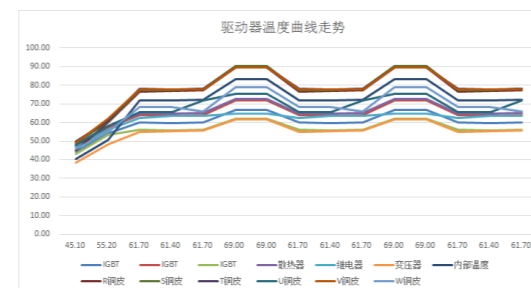

Complete protection

- ▶ The whole series has output to ground short circuit protection, over current protection, drive overload protection, motor overload protection, drive over temperature protection, optional PT100/PT1000 motor over temperature protection.
- ▶ According to the type of fault, it can be set as fault free stop, fault deceleration stop, fault continue to run, and facilitate the on-site handling of emergency situations.
- ▶ Adopting multiple high-quality three-proof paint to enhance the environmental adaptability of the product. The three-proof paint adopts the automatic spraying process to ensure the uniformity of the thickness of the coating and the consistency of the batch.

Powerful internal logic

- 1, Built-in up to 6 sets of delay functions, a wide variety of input sources, the output can be used as a variety of other built-in module inputs.
- 2, Built-in up to 4 sets of comparator units, any input, multiple comparison functions, the output can be used as a variety of other built-in module inputs.
- 3, Built-in up to 4 sets of logic units, arbitrary inputs, multiple logic operations, and outputs can be used as inputs for various other built-in modules.
- 4, The above modules can be used alone or in combination to achieve complex internal logic functions to meet various applications, saving peripheral equipment and wiring.

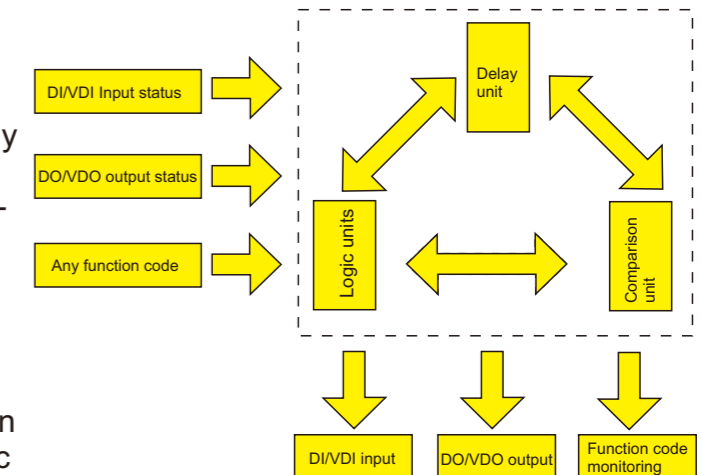

Rich expansion function

- ▶ Standard ModbusRTU communication function, support for fieldbus such as Profibus-DP, CanOpen, etc.
- ▶ Supports incremental encoders and resolvers, where incremental encoders are compatible with differential encoders and open collector encoders.
- ▶ Support for IO expansion



Powerful debugging software

- ▶ Support online oscilloscope function
- ▶ Support parameter backup and download
- ▶ Support function parameter modification
- ▶ Support inverter software online upgrade

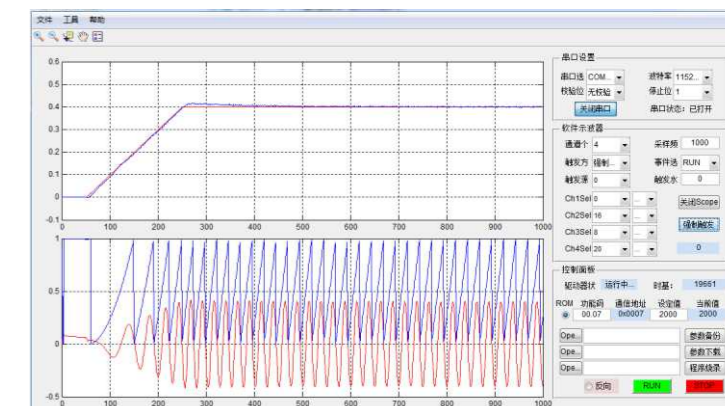

Multifunctional and user friendly

Deceleration over excitation function

- In many applications, the over-excitation function is set, the deceleration time is shortened by adjusting the motor output frequency and current, and the peripheral braking resistor and other accessories are reduced when the requirements for fast shutdown are met.

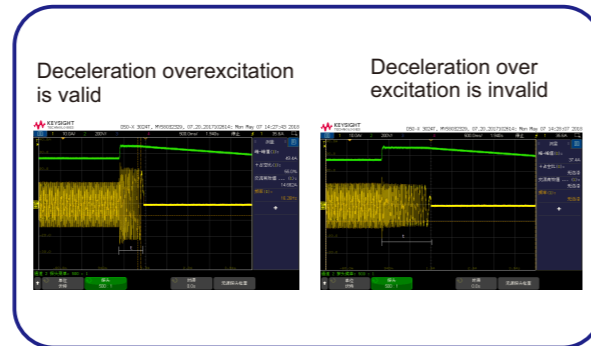

Undervoltage stall function

- When the system is powered off instantaneously, the motor is controlled by the regenerative energy during deceleration to maintain the inverter running for a short period of time and reduce the risk of idling under the instability of the grid.

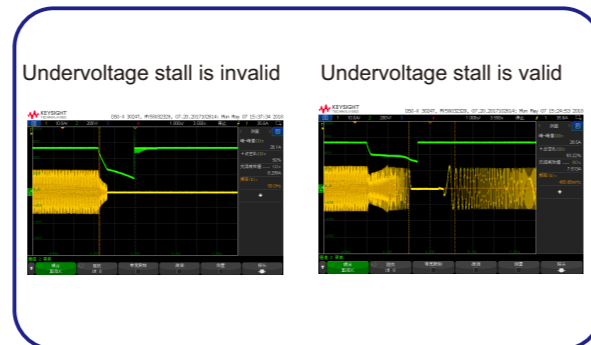

Excellent speed tracking

- Non-impact smooth start for motors that do not stop rotating

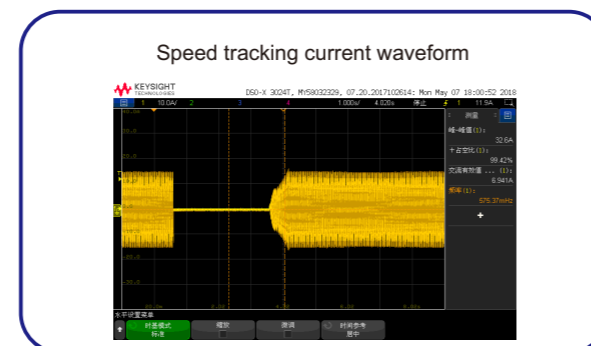

Energy saving function

- It has excellent automatic energy saving function, only need to set the maximum energy saving target, as long as the operation meets the energy saving condition, it can enter the automatic skill state.
- By setting the VF function, it can realize the application of 1 drag and long distance control to meet the application of the transformation occasion.

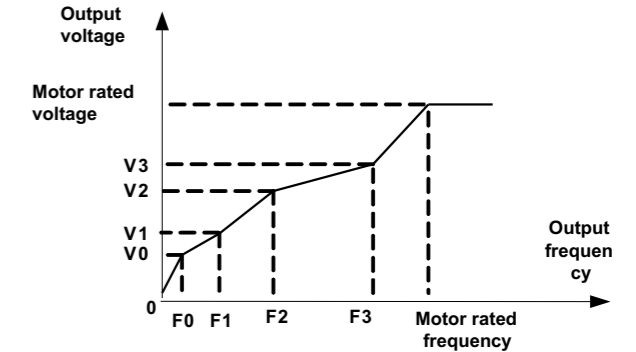
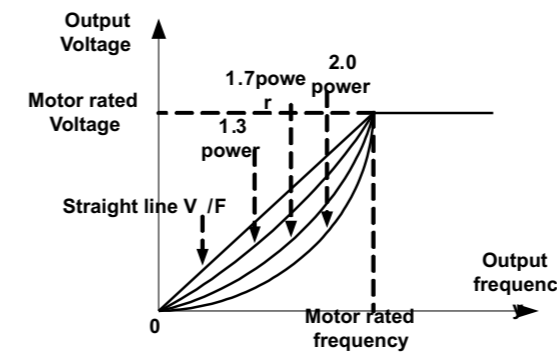
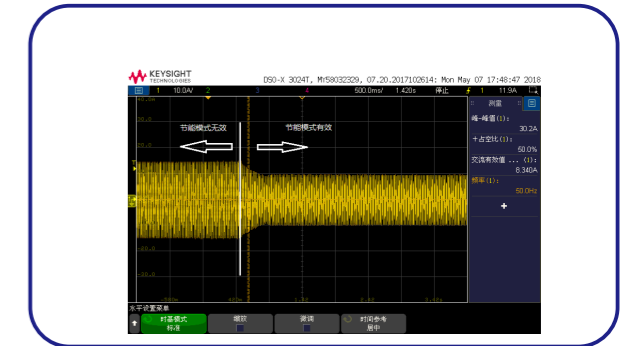

User-friendly operation

- 4 Keyboard modes: standard mode (-bSC-), user-defined mode (-USr-), check mode (-vrF-) and wizard mode (-GdE-), easy to switch.

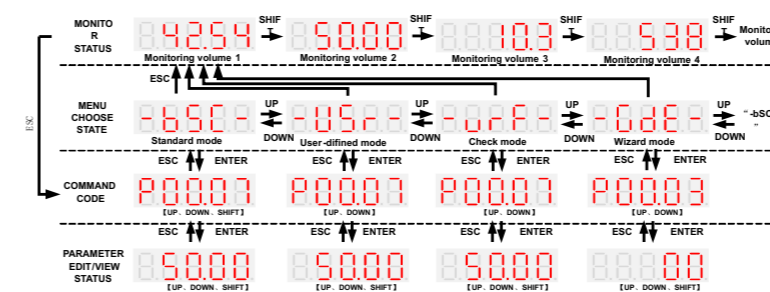

- Optional powerful LCD operator with parameter setting, parameter macro, monitoring, parameter copying, mobile phone Bluetooth, inverter program upgrade and other functions.



General Technical Data

Designation Rules

VFD500 - 4R0G/5R5P T4B

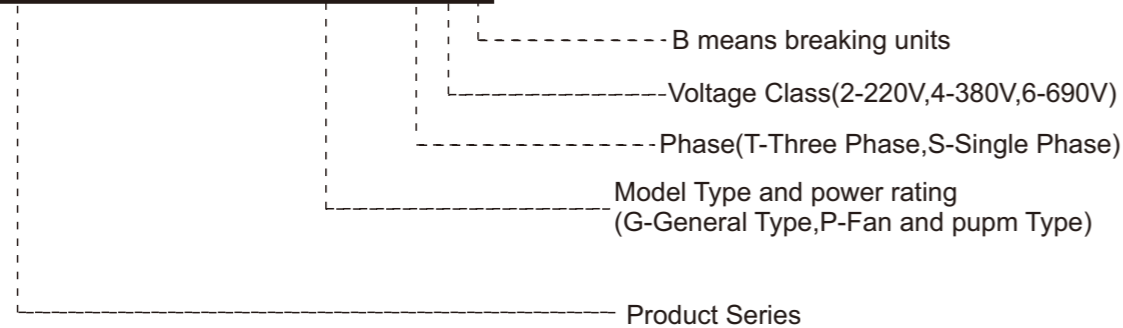

Appearance and Mounting Hole Dimension

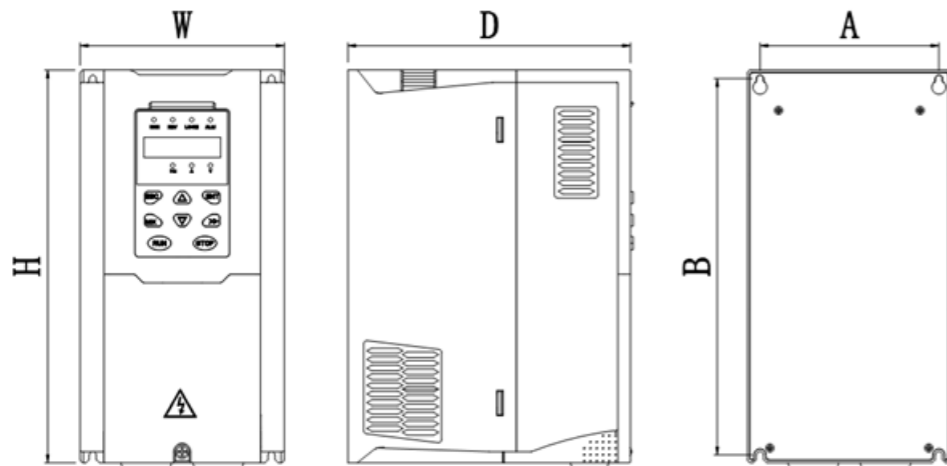

SIZE	Appearance and installation dimension (mm)									
	A	B	B2	H	H1	H2	W	D	F d	Mounting
0.75KW-4KW	87	206.5	/	215	/	/	100	170	ø5.0	M4X16
5.5KW-7.5KW	113	239.5	/	250	/	/	130	180	ø5.0	M4X16
11KW-15KW	153	299	/	310	/	/	170	193	Ø6.0	M5X16
18.5KW-22KW	165	350	/	370	335	/	210	205	Ø6.0	M5X16
30KW-37KW	218	438	/	452.5	424	/	260	230	Ø7.0	M6X16
45KW-55KW	250	535	/	555	520	/	320	275	Ø10.0	M8X20
75KW-90KW	280	620	/	640	605	/	350	290	Ø10.0	M8X20
110KW	280	695	915	715	660	935	370	313	Ø11.0	M8X25
132KW-160KW	280	705	925	725	670	945	360	338	Ø11.0	M8X25
185KW-200KW	360	795	1145	816	762	1166	490	358	Ø11.0	M10X25
220KW-250KW	360	795	1145	816	762	1166	490	358	Ø11.0	M10X25
280KW-315KW	Flooring mounting:H2*W*D=1166*490*358									
	450	1045	1495	1075	1005	1560	550	450	Ø13.0	M12X30
355KW-400KW	Flooring mounting:H2*W*D=1560*550*450									
	630	1013	1425	1045	970	1495	730	450	Ø13	M12*30
450KW-500KW	Flooring mounting:H2*W*D=1495*730*450									
	660	1063	1505	1095	1020	1575	785	450	Ø13	M12*30
560KW-710KW	Flooring mounting:H2*W*D=1575*785*450									
560KW-710KW	Only for Flooring mounting:H2*W*D=1800x1080x500									M12*30

Model	Power capacity	Input current	Output current(A)		Adaptable Motor	SIZE	Brake Unit
			Heavy	Light			
Three phase: 380-480V, 50/60Hz							
VFD500-R75GT4B	1.5	3.4	2.5	4.2	0.75	SIZE A	Internal
VFD500-1R5GT4B	3	5	4.2	5.6	1.5		
VFD500-2R2GT4B	4	5.8	5.6	9.4	2.2		
VFD500-4R0G/5R5PT4B	5.9	10.5	9.4	13.0	3.7	SIZE B	
VFD500-5R5G/7R5PT4B	8.9	14.6	13.0	17.0	5.5		
VFD500-7R5G/011PT4B	11	20.5	17.0	23.0	7.5	SIZE C	
VFD500-011G/015PT4B	17	26.0	25.0	31.0	11		
VFD500-015G/018PT4B	21	35.0	32.0	37.0	15		
VFD500-018G/022PT4B	24	38.5	37.0	45.0	18.5	SIZE D	
VFD500-022G/030PT4B	30	46.5	45.0	57.0	22		
VFD500-030G/037PT4	40	62.0	60.0	75.0	30	SIZE E	
VFD500-037G/045PT4	50	76.0	75.0	87.0	37		
VFD500-045G/055PT4	60	92.0	90.0	110.0	45	SIZE F	
VFD500-055G/075PT4	75	113.0	110.0	135.0	55		
VFD500-075G/090PT4	104	157.0	152.0	165.0	75	SIZE G	
VFD500-090G/110PT4	112	170.0	176.0	210.0	90		
VFD500-110G/132PT4	145	220.0	210.0	253.0	110	SIZE H	
VFD500-132G/160PT4	170	258.0	253.0	304.0	132		
VFD500-160G/185PT4	210	320.0	304.0	360.0	160	SIZE I	
VFD500-185G/200PT4	245	372.0	360.0	380.0	185		
VFD500-200G/220PT4	250	380.0	380.0	426.0	200	SIZE J	
VFD500-220G/250PT4	280	425.0	426.0	465.0	220		
VFD500-250G/280PT4	315	479.0	465.0	520.0	250	SIZE K	
VFD500-280G/315PT4	350	532.0	520.0	585.0	280		
VFD500-315G/355PT4	385	585.0	585.0	650.0	315	SIZE L	
VFD500-355G/400PT4	420	638.0	650.0	725.0	355		
VFD500-400G/450PT4	470	714.0	725.0	820.0	400	SIZE M	
VFD500-450G/500PT4	530	800.0	820.0	/	450		
VFD500-500G/560PT4	580	880.0	900.0	/	500	SIZE N	
VFD500-560G/630PT4	630	950.0	980.0	/	560		
VFD500-630GT4	710	1080	1120.	/	630	SIZE N	
VFD500-710GT4	790	1200	1260	/	710		
Single phase :220V ,50/60HZ							
VFD500-R40GS2	1.3	6.0	3.2	5.6	0.4	SIZE A	Inbuilt
VFD500-R75GS2	2.4	11.0	5.6	8.0	0.75	SIZE A	
VFD500-1R5GS2	3.5	15.0	8.0	10.6	1.5	SIZE A	
VFD500-2R2GS2	5.5	25.0	10.6	14.0	2.2	SIZE A	
VFD500-4R0GS2	7.7	35.0	17.0	23.0	4.0	SIZE B	
VFD500-5R5GS2	8.9	53.0	25.0	31.0	5.5	SIZE C	
VFD500-7R5GS2	11	67.0	32.0	37.0	7.5	SIZE C	

General Technical Data

Item		Specification
Input	Inuput Voltage	1phase/3phase 220V: 200V~240V 3 phase 380V-480V: 380V~480V
	Allowed Voltage fluctuation range	-15%~10%
	Input frequency	50Hz / 60Hz, fluctuation less than 5%
Output	Output Voltage	3phase: 0~input voltage
	Overload capacity	General purpose application: 60S for 150% of the rated current Light load application: 60S for 120% of the rated current
Control	Control mode	V/f control Sensorless flux vector control without PG card (SVC) Sensor speed flux vector control with PG card (VC)
	Operating mode	Speed control, Torque control (SVC and VC)
	Speed range	1:100 (V/f) 1:200(SVC) 1:1000 (VC)
	Speed control accuracy	±0.5% (V/f) ±0.2% (SVC) ±0.02% (VC)
	Speed response	5Hz(V/f) 20Hz(SVC) 50Hz(VC)
	frequency range	0.00~600.00Hz(V/f) 0.00~200.00Hz(SVC) 0.00~400.00Hz(VC)
	Input frequency resolution	Digital setting: 0.01 Hz Analog setting: maximum frequency x 0.1%
	Startup torque	150%/0.5Hz(V/f) 180%/0.25Hz 180%/0Hz(VC)
	Torque control accuracy	SVC: within 5Hz10%, above 5Hz5% VC:3.0%
	V/f curve	V / f curve type: straight line, multipoint, power function, V / f separation; Torque boost support: Automatic torque boost (factory setting), manual torque boost
	Frequency giving ramp	Support linear and S curve acceleration and deceleration; 4 groups of acceleration and deceleration time, setting range 0.00s~60000s
	DC bus voltage control	VdcMax Control: Limit the amount of power generated by the motor by adjusting the output frequency to avoid over-voltage trip; VdcMin control: Control the power consumption of the motor by adjusting the output frequency, to avoid jump undervoltage fault
	Carrier frequency	1kHz~12kHz(Varies depending on the type)
	Startup method	Direct start (can be superimposed DC brake); speed tracking start
	Stop method	Deceleration stop (can be superimposed DC braking); free to stop

General Technical Data

Item		Specification
Main control function		Jog control, droop control, up to 16-speed operation, dangerous speed avoidance, swing frequency operation, acceleration and deceleration time switching, VF separation, over excitation braking, process PID control, sleep and wake-up function, built-in simple PLC logic, virtual Input and output terminals, built-in delay relay, built-in comparison unit and logic unit, parameter backup and recovery, perfect fault record, fault reset, two groups of motor parameters freely switch, software swap output wiring, terminals UP / DOWN
	Keypad	LED Digital keyboard and LCD keypad(option)
function	communication	Standard: MODBUS communication Option:Profibus-DP and CAN OPEN
	PG card	Incremental Encoder Interface Card (Differential Output and Open Collector), Rotary transformer Card
	Input terminal	standard: 5 digital input terminals, one of which supports high speed pulse input up to 50kHz; 2 analog input terminals, support 0 ~ 10V voltage input or 0 ~ 20mA current input; Option card: 4 digital input terminals 2 analog input terminals.support-10V-+10V voltage input
	Output terminal	standard: 1 digital output terminal; 1 high-speed pulse output terminal (open collector type), support 0 ~ 50kHz square wave signal output; 1 relay output terminal (relay 2 is an option) 2 analog output terminals, support 0 ~ 20mA current output or 0 ~ 10V voltage output; Option card: 4 digital output terminals
Protection	Refer to Chapter 6 "Troubleshooting and Countermeasures" for the protection function	
Environment	Installation location	Indoor, no direct sunlight, dust, corrosive gas, combustible gas, oil smoke, vapor, drip or salt.
	Altitude	Lower than 1000 m
	Ambient temperature	-10°C~ +40°C (derated if the ambient temperature is between 40°C and 50°C)
	Humidity	Less than 95%RH, without condensing
	Vibration	Less than 5.9 m/s ² (0.6 g)
	Storage temperature	-20°C ~ +60°C
others	Installation	Wall-mounted, floor-controlled cabinet, transmural
	Protection level	IP20
	cooling method	Forced air cooling

General Technical Data

Type	Terminal Symbol	Terminal Name	Terminal function description
Analog input voltage	+10V	Input voltage	10.10V±1% Maximum output current:10mA, it provides power supply to external potentiometer with resistance range of 1KΩ~51KΩ
	GND	Ananog ground	Internal isolation from COM
	AI1	Analog input1	Input voltage:0~10V: Impedance 22KΩ, Maximum input voltage
			Input current:0~20mA: Impedance 500Ω, Maximum input current
			Through the jumper switch AI1 0 ~ 10V and 0 ~ 20mA analog input switch, the factory default voltage input.
	AI2	Analog input 2	Input voltage:0~10V: Impedance 22KΩ, Maximum input voltage
Input current:0~20mA: Impedance 500Ω, Maximum input current			
Through the jumper switch AI1 0 ~ 10V and 0 ~ 20mA analog input switch, the factory default voltage input.			
Analog output	AO1	Analog output 1	Output voltage:0~10V: Impedance ≥10KΩ
			Output current:0~20mA: Impedance 200Ω~500Ω
			Through the jumper switch AO1 0 ~ 10V and 0 ~ 20mA analog output switching, the factory default voltage output.
	AO2	Analog output 2	Output voltage:0~10V: Impedance ≥10KΩ
Output current:0~20mA: Impedance 200Ω~500Ω			
GND	Ananog ground	Internal isolation from COM	
Switch input	+24V	+24V current	24V±10%, Internal isolation from GND
			Maximum output current: 200mA
			To provide 24V power supply, generally used as a digital input and output terminal power supply and external sensor power
	PLC	Digital input terminal common	The factory default setting is connected PLC with +24V
			Terminal for on-off input high and low level switch
	COM	+24V ground	Internal isolation from GND
	DI1~DI4	Digital input terminal 1~4	Optocoupler isolation, compatible with bipolar input
Frequency range: 0~200Hz			
Voltage range: 10V~30V			
HDI	Digital input terminal /High-speed pulse input	Digital input terminal: same as DI1~DI4	
		Pulse input frequency input: 0~50KHz	
		Voltage range: 10V~30V	

Type	Terminal Symbol	Terminal Name	Terminal function description
Switch output	DO1	Open collector output	Optocoupler isolation
			Voltage range: 0V~24V
Switch output	HDO	Open collector output /High-speed pulse output	Current range: 0mA ~50mA
			Open collector output: same as DO1
Relay output 1	TA/TB/TC	Relay output	High-speed pulse output: 0~50KHz
			T1A-T1C: nomal open
			T1A-T1B: nomal close
Relay output2 (optional)	T2A/T2BT2C	Relay output	Contact rating: AC 250V, 3A; DC 30V, 1A
			T2A-T2C: nomal open
			T2A-T2B: nomal close
485 port	485+	485 Positive differential signal	Baud rate: 1200/2400/4800/9600/19200/38400/57600/115200bps
	485-	485 Negative differential signal	

VFD500 Option Parts

	triple Incremental PG card/open collector PG card/differeninal PG card/Rotary PG card	1,A+/A-,B+/B-,Z+/Z- Pluse input 2,Max input Frequency:100KHz 3,PG power output:+15V 4,10KHz 7V Rms output,DB9 port,no frequency division output,resolution 12 digits
	IO extension card	4 DI terminal 4 DO terminal 2 analog input
	IO board	7 DI terminals ,2 AI 2 AO,2 Relay
	Communication extension card	Canopen Profibus-DP
	LCD keypad	removable and remote keypad extendable and 100m remote control support data copy function

Control Circuit and Main Circuit Wiring

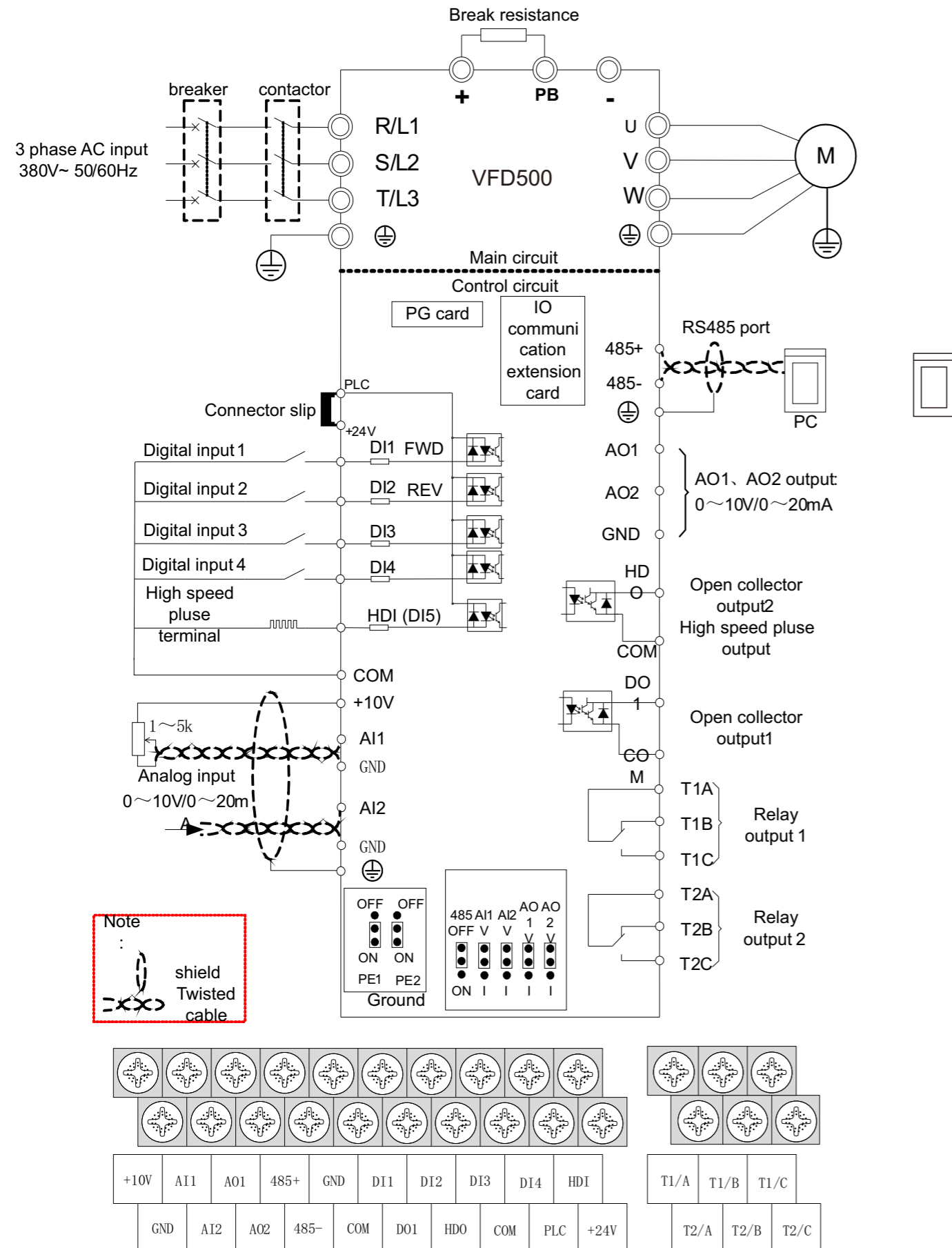

Widely applications



Hoisting Industry
mine hoist, mining electric locomotive port hoist, builders' lift, pile driver, large crane motor, tower crane lifting



Petroleum Industry
plunger pump, beam pumping unit, oil transfer pump, gas transmission pipeline system compressor



Chemical Industry
vacuum kneader (agitator), dryer film blowing machine, plastic mill, pulverizer drafting device for short fiber, high speed spinning machine for chemical fiber feedstock pump for oil refinery, pump for cooking unit



Power Industry
boiler blower, induced draft fan, boiler feeding pump, circulating water pump, low pressure drain pump, condensate pump, cooling water pump, mortar pump, coal feeder



Textile Industry
Spinning machine, fagoting machine, pounding machine, knitting machine, centrifugal dehydrator, spinning frame, aeration machine for print works, tentering and thermo-fixing machine, high temperature dyeing machine, decorating machine, bleaching machine, dyeing jiggers



Iron and steel industry
winding engine for iron-smelting blast furnace, dust removing blower for blast furnace, air blower for blast furnace gas blanketing blowing engine, roots blower for digital thermometer, variable frequency exhaust fan for steel furnace roasting and purifying fan, hot rolling machine, cold tandem rolling mill, feeding system, mill exhauster, vibrating sieving machine, wired drawing machine, winding machine, blender mixer, drying machine, slime pump, draining pump, water supply pump, unbender, pipemaking machine, ladle crane motor



Heating System
constant pressure water supply system for boiler, mill exhauster, belt conveyor for coal, coal breaker, air blower, induced draft fan, cold-rolling mill

Winding Machine

lithium battery winding machine, capacitor core winding machine, textile winding machine



Pump

petroleum pump, metallurgical pump, chemical pump, fishing pump, mining pump, power pump, water conservation pump, sewage pump, food pump, brewing pump, pharmacy pump, beverage pump, fuel pump, condiment pump, paper pump, textile pump, printing and dyeing pump, ceramic pump, paint conveyer pump, agricultural chemical pump, ...



Compressor

piston compressor, screw compressor, centrifugal compressor, linear compressor



Conveyor Belt

belt-type conveyor, plate conveyor, car type conveyor, escalator, passenger conveyor, scraper conveyor, embedded scraper conveyor, bucket conveyor, bucket elevator, underslung conveyor



Machine Tool industry

nc-electro-spindle, vertical lathe spindle, surface grinder spindle, boring machine spindle, sawing machine



Injection Molding Machine

extruding machine, injection machine, disc refiner, internal mixer, granulate machine



Fan Industry

centrifugal compressor, axial-flow compressor, centrifugal blower, roots blower, centrifugal fan, axial flow fan, enke blower



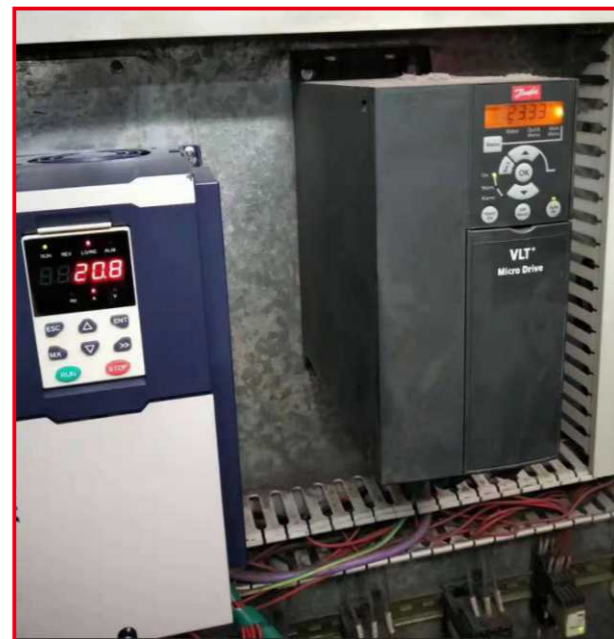
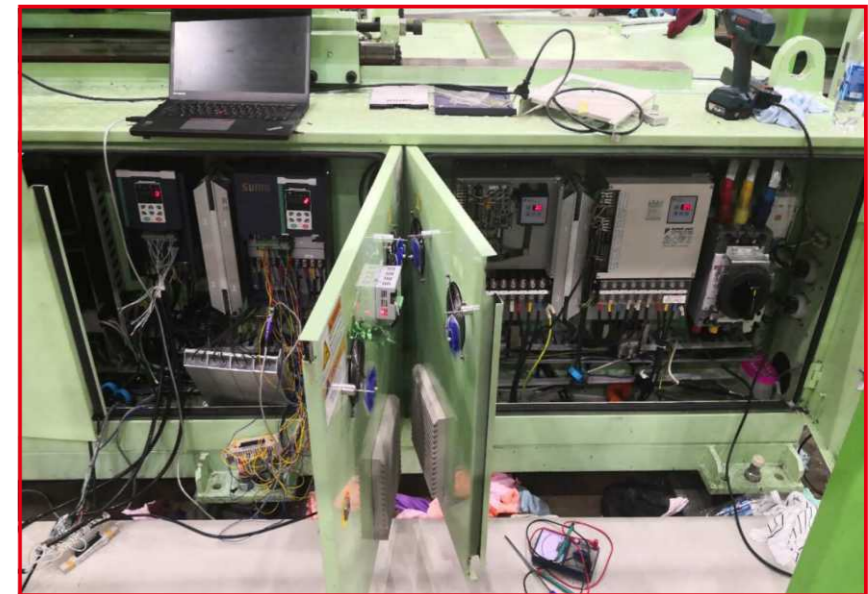
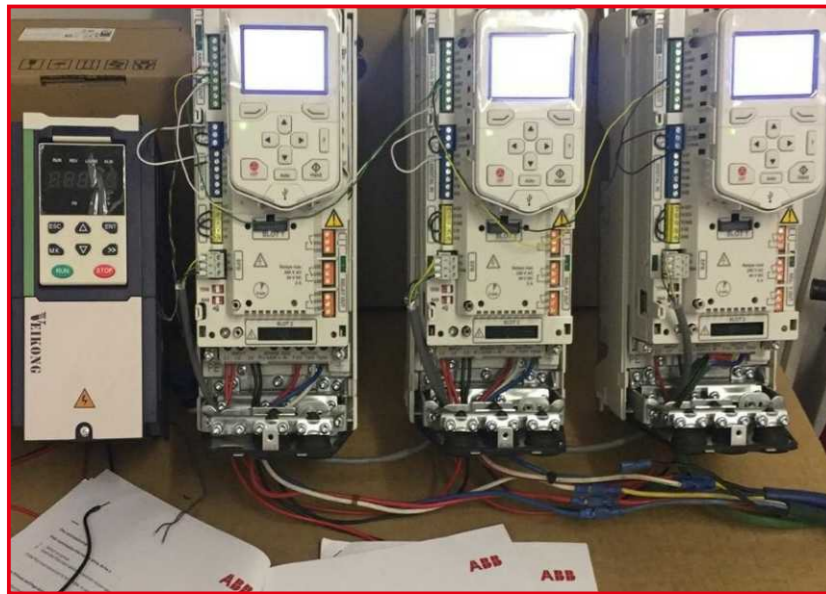

VFD500M AC Drive

Open Loop General Purpose & Economical

Features & Functions

- V/F & sensorless vector control
- Starting torque 150% at 0.25Hz in SVC
- HDI and HDO function
- Automatic torque boost
- Support LCD display
- Easy startup with simplified parameters
- 2-Independent S-ramps
- Vector/torque control
- Variable DC injection braking
- Energy saving
- Self-definition parameter
- In-built dynamic braking unit



- NEW** Internal EMC filter
- Complies with EN61800-3 Category C3 3rd Environment
- NEW** output frequency 3000hz
- Operation in high ambient temperature $45^{\circ}\text{C}_{\text{avg}}$
- Enhanced reliability protection against humidity and pollution dust
- Onboard Comms Modbus RTU

Widely applications

Pumping/ventilating/compressing	Centrifugal pumps Radial/axial fans Compressors			
Moving	Conveyor belts Roller conveyors Chain conveyors			
Processing	Mills Mixers Kneaders Crushers Agitators Centrifuges			

General Specifications

Voltage Class		Single-phase 220 Vac				Three-phase 400 Vac			
Drive Model: VFD500M-R75GS2B		S0.4B	S0.75B	S1.5B	S2.2B	T0.75B	T1.5B	T2.2B	T4.0B
Dimension	Height Width Depth	[H]: 145 mm [W]: 75 mm [D]: 115 mm				[H]: 175 mm [W]: 86 mm [D]: 128 mm			
Drive Input	Rated input voltage	Single-phase 200 to 240 Vac, -15% to +10%				Three-phase 380 to 480 Vac, -15% to +10%			
	Rated input current [A]	6.9	12.2	17.0	21.0	4.7	5.5	6.5	11
	Power capacity [kVA]	1.2	2.1	3.1	4.1	1.5	3.0	4.0	5.9
	Rated input frequency	50/60 Hz, $\pm 5\%$ (47 to 63 Hz)							
Drive Output	Applicable motor [kW]	0.4	0.75	1.5	2.2	0.75	1.5	2.2	4.0
	[HP]	0.5	1	2	3	1	2	3	5
	Output Current [A] ^{*4}	2.8	4.5	8	10.6	2.5	4.2	5.6	9.4
	Overload Capacity	150% for 60 Sec & 180% for 3 Sec							
	Max. output voltage	200 to 240 Vac (Proportional to input voltage)				380 to 480 Vac (Proportional to input voltage)			
Max. output frequency	3000 Hz								
Braking Resistor	Recommended power [kW]	80	80	100	100	150	250	300	500
	Recommended resistance [Ω]	≥ 200	≥ 150	≥ 100	≥ 70	≥ 300	≥ 220	≥ 200	≥ 130
Enclosure ^{*5}	IP 20								

^{*4} Carrier switching frequency 6 kHz at rated output current.
^{*5} Size A is natural cooling, Size B are fan cooling/fan cooled.

General Connection Diagram

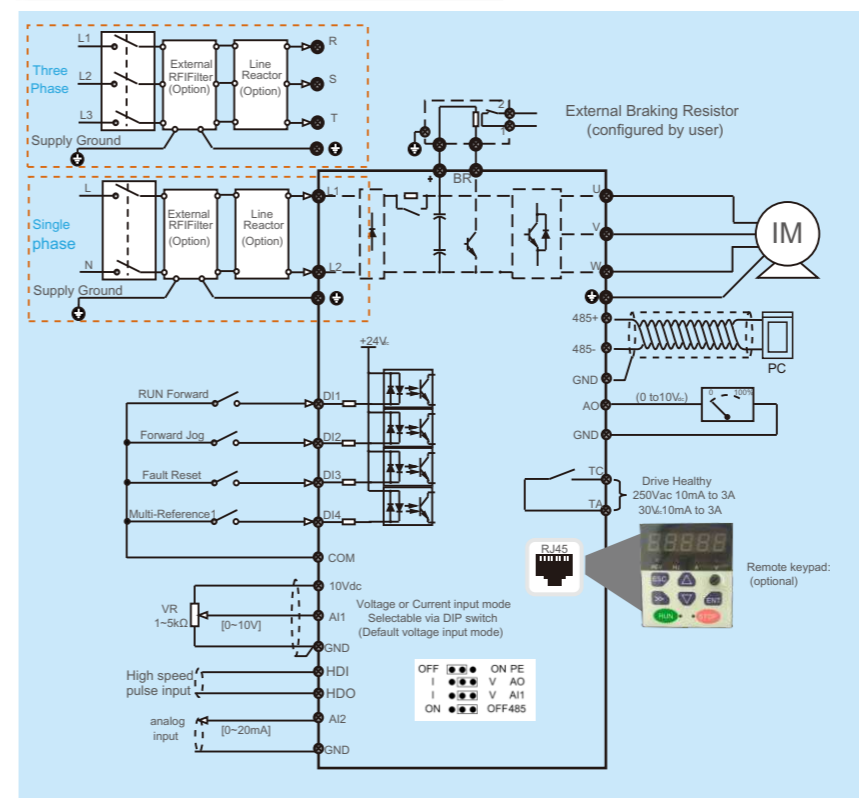

Dimension

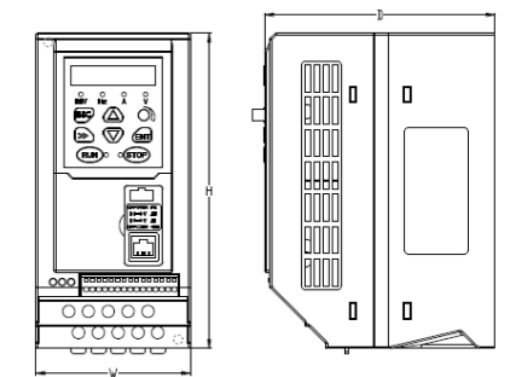

Size A: 145*75*115mm
Size B: 175*86*128mm

Remote Keypad (optional)

Model: MDKE8 (LED type)
Dimension: 116Hx76Wx40D(mm)
Protection level: IP20
Matching Cable Model: MD CAB 3.0m (included)
speed potentiometer(single turn)